

57074



57071



68672



47054

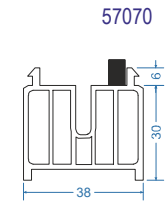
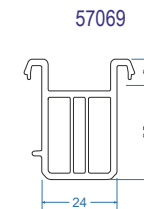
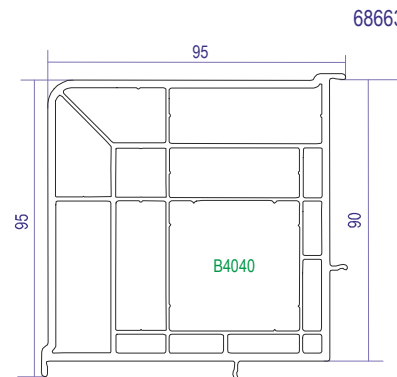
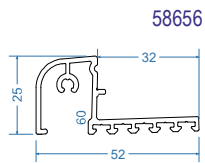
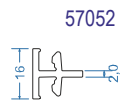
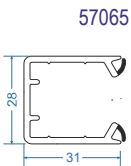
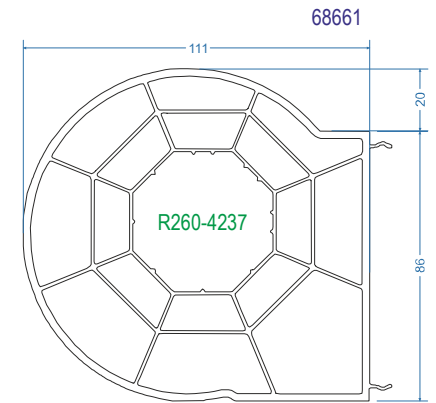
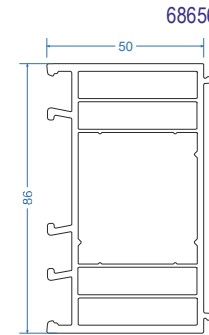
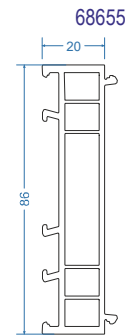

68641

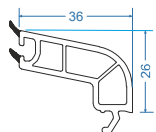

68642

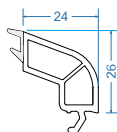

68643

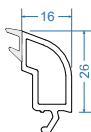

68640



68644

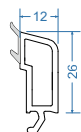

68645

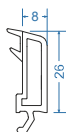

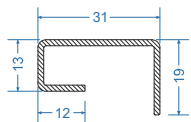
A3119

A	X	Y
1,50	1,26	0,25
2,00	1,41	0,32

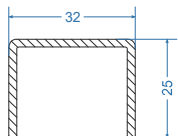
A3225

A	X	Y
1,50	2,01	0,76
2,00	2,57	0,98

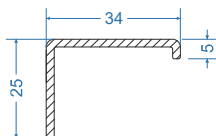
L3425

A	X	Y
1,50	1,28	0,49

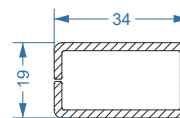
B3419

A	X	Y
1,50	2,20	0,87
2,00	2,73	1,07

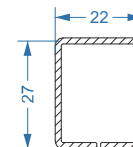
B2822

A	X	Y
1,50	1,02	1,46
2,00	1,28	1,85

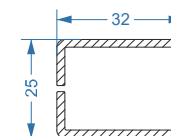
B3225

A	X	Y
1,50	2,22	1,55
2,00	2,84	1,96

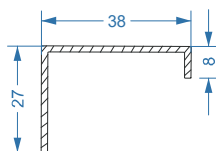
L3827

A	X	Y
1,50	1,94	0,62

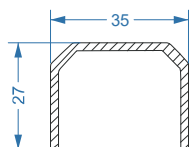
A3527

A	X	Y
1,50	2,48	0,93
2,00	3,18	1,20

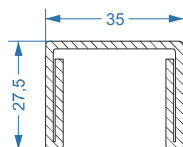
A3528

A	X	Y
2,00	5,24	1,98
2,50	6,18	2,48

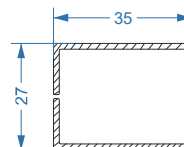
B3527

A	X	Y
1,50	2,86	1,98
2,00	3,70	2,50

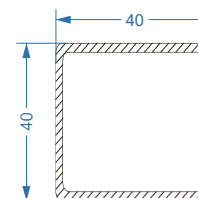
B4040

A	X	Y
2,00	7,13	7,21

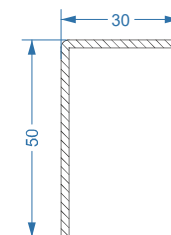
A3050

A	X	Y
1,50	3,26	4,94
2,00	4,18	6,48

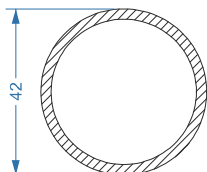
R260-4237

A	X	Y
2,60	7,27	7,27

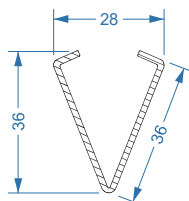
V3628

A	X	Y
2,00	1,71	1,12

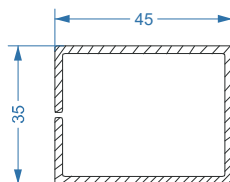
B4535

A	X	Y
1,50	xxx	xxx
2,00	8,66	5,67

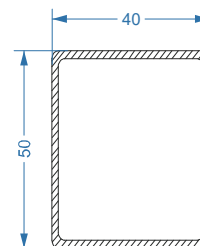
B4050

A	X	Y
2,00	8,50	14,50
3,00	11,40	16,10

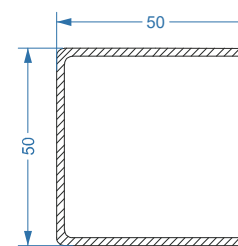
B5050

A	X	Y
2,00	14,70	14,70
3,00	20,00	20,00

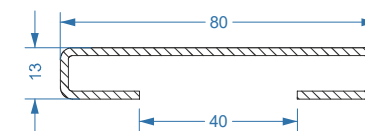
S13820

A	X	Y
2,00	20,40	0,70

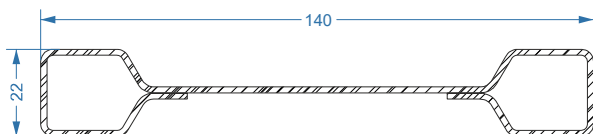
150S14022

A	X	Y
2,00	XXX	XXX

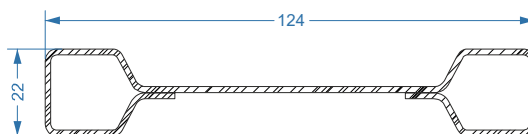
150S12422

A	X	Y
2,00	XXX	XXX

L	M	I	A
1	A3119	150A3119	1,50
2	A3225	200A3119	2,00
3	A3050	150A3225	1,50
4	A3527	200A3225	2,00
5	L3827	150A3119	1,50
6	L3425	150A3527	1,50
7	B3419	200A3527	2,00
8	B2822	150B3419	1,50
9	B3225	200B3419	2,00
10	B3527	150B2822	1,50
11	B3528	200B2822	2,00
12	B4535	150B3225	1,50
13	B4040	200B3225	2,00
14	B4050	150B3527	1,50
15	B5050	200B3527	2,00
16	R4237	300B3528	3,00
17	S14022	150B4535	1,50
18	S12422	200B4535	2,00
19	S13820	200B4040	2,00
20	V3628	200B4050	2,00

L - kolejny numer wzmocnienia
M. - model/kształt wzmocnienia
I - pełny index wzmocnienia

A - grubość stali kształtownika w mm
X - moment bezwładności stali w cm⁴ w płaszczyźnie x
Y - moment bezwładności stali w cm⁴ w płaszczyźnie y